

# PURKEYS

## SELECT™-25

---

### INSTALLATION GUIDE





# CONTENTS

---

|  |    |
|--|----|
| General Information.....                 | 2  |
| Select-25 Diagram.....                   | 3  |
| Mounting the Select Controller.....      | 4  |
| Dual/Single Nosebox Installation .....   | 5  |
| Aux Harness Installation .....           | 6  |
| 7-Way Nosebox Tips .....                 | 8  |
| Main Harness Installation.....           | 9  |
| Part List .....                          | 13 |
| Limited Commercial Warranty Policy ..... | 16 |

## GENERAL INFORMATION

---

The Purkeys Select™ system allows charging from multiple sources and improves the charging of liftgate batteries by utilizing a DC/DC converter to boost the voltage for optimal charging. The boost in voltage overcomes the normal voltage drop caused by the extended distance between the liftgate batteries and the vehicle charging system. Also, in cold temperatures batteries require increased charging voltages to maintain a high state of charge. The DC/DC converter in the Select system compensates for temperature by providing higher charging voltages in cold weather. The result is well-charged liftgate batteries that will last longer and have ample power for liftgate operation.

The Select system is automatic and has easy-to-interpret LED indicators to assure drivers and technicians of proper system function. The Select Controller increases the time that the DC/DC converter can charge the liftgate batteries by automatically choosing the best available source of power (tractor or reefer) and by monitoring the source power and “extending” the liftgate battery charge time to take full advantage of the available power, without compromising the source batteries’ ability to crank the engine.

The Select system provides opportunity charging for liftgate batteries that is essential in low mileage, high frequency liftgate operation applications. The LED indicators clearly show the status of the source as well as the status of the liftgate batteries. A quick glance at the Select Controller assures the driver that the liftgate batteries are ready to go, or alerts the driver that the batteries need maintenance.

# SELECT-25 INSTALLATION GUIDE

## SELECT-25 DIAGRAM

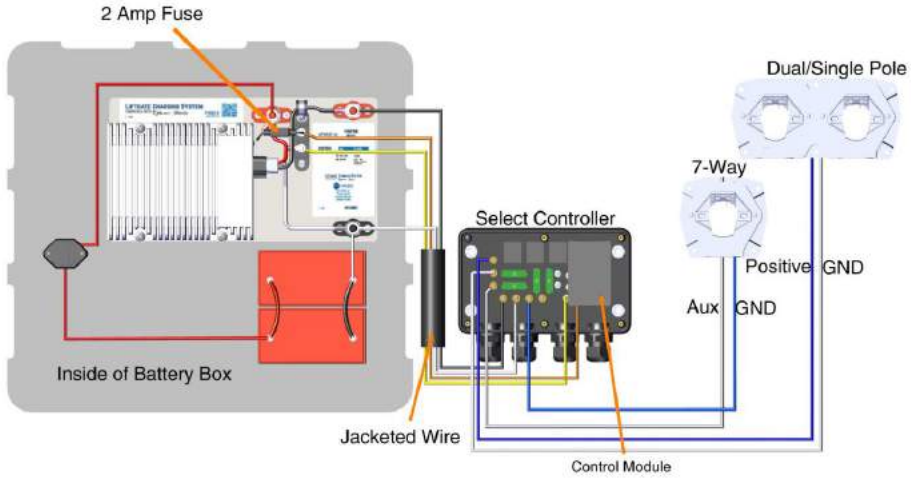

## MOUNTING THE SELECT CONTROLLER

Step 1: Using the supplied mounting screws, mount the Select Controller at the front of the trailer via the mounting holes on the plate.



NOTE: Do not block the LED status decal on the side of the Select when mounting the Select Controller.



Installation Complete.

# SELECT-25 INSTALLATION GUIDE

## DUAL/SINGLE NOSEBOX INSTALLATION

---

Step 1: Mount the dual/single pole nosebox close to the Select Controller.

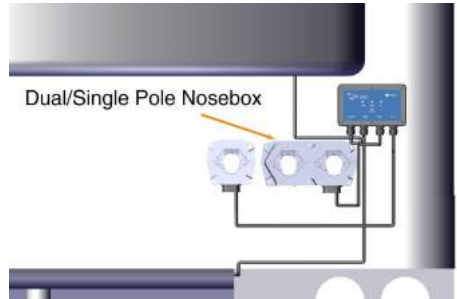

Installation Complete.

## AUX HARNESS INSTALLATION

---

Step 1: Route the jacketed 2-conductor from the Select controller over to the 7-way nosebox.



Note: Place the cable clamps along the 7-way aux harness every 6 inches to ensure proper support for the cable. Avoid sharp edges and possible chaffing points.

Step 2: Position the 2-conductor harness so that it reaches the ground pin on the top of the 7-way receptacle and the aux pin in the center of the 7-way receptacle. Mark the cable, and cut to length.



Step 3: Slide the supplied red 1/2 inch heat shrink over the blue wire. Slide the supplied black 1/2 inch heat shrink over the white wire.





## SELECT-25 INSTALLATION GUIDE

Step 4: Crimp on the supplied 10 gauge #10 eyelets onto both the blue and white wires.



Step 5: Solder, then position the heat shrink over the crimps and apply heat to the 2 terminals.



Note: Place the cable clamps along the 7-way aux harness every 6 inches to ensure proper support for the cable. Avoid sharp edges and possible chaffing points.

Installation Complete

## 7-WAY NOSEBOX TIPS

- Inspect circuits inside the 7-way box for excessive electrical resistance caused by overheating, corrosion, loose/poor connections, or undersized wiring.
- Check to see if the 7-way nosebox is equipped with circuit breakers (see Figure 1), as the problem may be a failing circuit breaker. Either replace circuit breaker with a new part or connect the blue wire from the Select Controller to the unprotected side of the circuit breaker. Circuit protection is provided by the 30 amp fuse inside the Select Controller.
- Ensure the 7-way or stinger cord has a tight fit and has good electrical contact at the tractor and trailer receptacles.



Figure 1: 7-Way Nosebox



**SERVICE TIP** - Purkeys offers the Liftgate Double Check tool, which can simplify the diagnosis of liftgate charging system problems caused by excessive voltage drop. For more information on the tool, please call 1-800-219-1269 or visit our website at [www.purkeys.net](http://www.purkeys.net).

# SELECT-25 INSTALLATION GUIDE

## MAIN HARNESS INSTALLATION

Step 1: Route the Select 4-conductor jacketed DC/DC converter main harness behind the front plate, then behind the header plate through the air/electrical tube to the center channel.

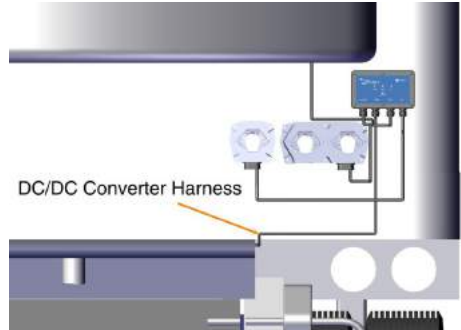

Step 2: Route the Select jacketed 4-conductor main harness in the center channel toward the back of the trailer. Secure with wire ties or cable clamps as you go.



Place the cable clamps along the 4-conductor jacketed wire every 6 inches to ensure proper support for the cable. Avoid sharp edges and possible chaffing points.

Step 3: Once you are near the liftgate battery box, begin routing the Select 4-conductor main harness into the liftgate battery box through a dome nut or rubber grommet.



Note: Ensure that the 4-conductor jacketed wire enters the liftgate battery box through a dome nut or rubber grommet to prevent chaffing the wire, which could result in possible electrical short in the system.

**Step 4:** Position the Select 4-conductor main harness so it will reach the 2-stud strip and all the slack has been taken up. Mark the wire so it can be taken back out of the battery box to be terminated.



**Note:** If your battery box includes a slide-out tray, include enough slack to allow the tray to fully extend without tugging the wire connections.

**Step 5:** Pull the conductor out of the box (easier to work on), and cut off the excess at the mark.



**Step 6:** Cut about 8 inches off the jacketed portion off the conductor.

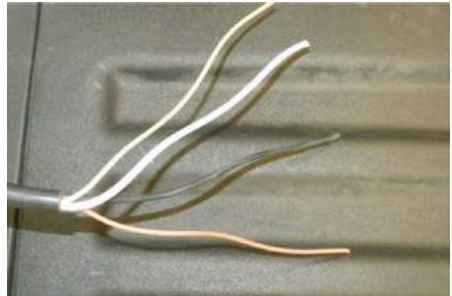

**Step 7:** Apply the supplied inch black heat shrink where the jacket was stripped off.

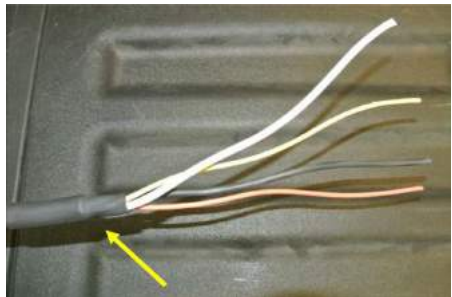

## SELECT-25 INSTALLATION GUIDE

Step 8: Strip 3/8 inch of insulation off all 4 wires.

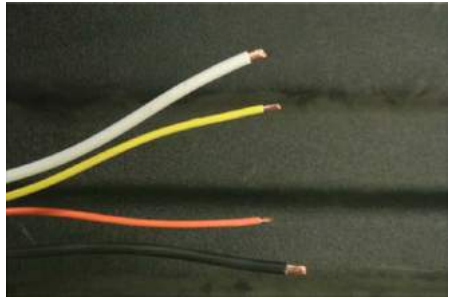

Step 9: Slide the supplied red 1/2 inch heat shrink over the orange, yellow, and black wires. Slide the supplied black 1/2 inch heat shrink over the white wire.

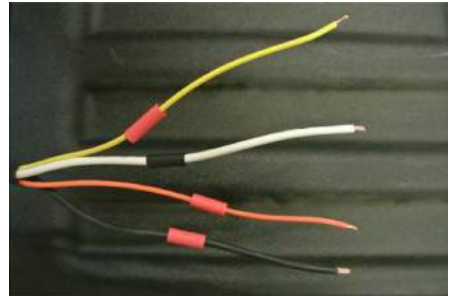

Step 10: Crimp terminals onto the 4 wires. The white and black 8-gauge wires use the 3/8 ring terminals, and the orange 14-gauge wire and yellow 16-gauge wire use the #10 ring terminals.

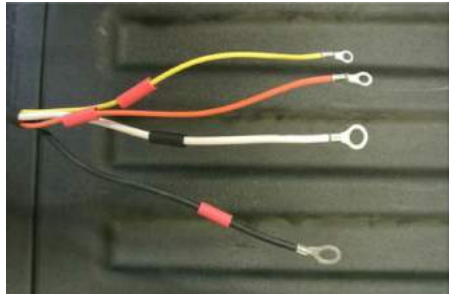

Step 11: Position the heat shrink over the crimps and apply heat to the 4 terminals.

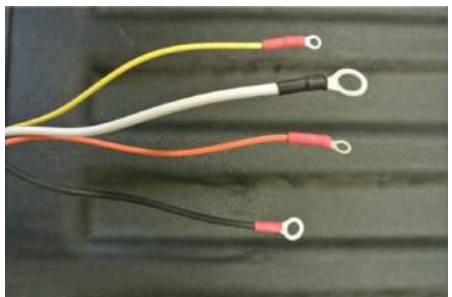

Step 12: Re-route the jacketed wire back into the battery box.

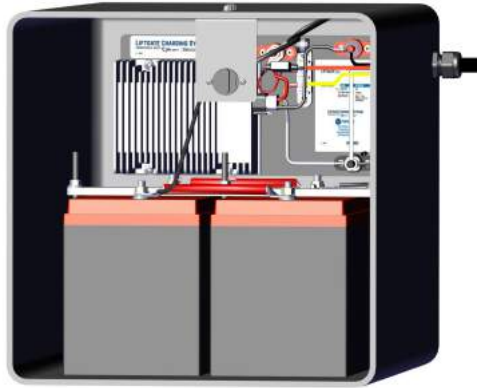

- Connect the 8-gauge black wire to the red positive Input stud.
- Connect the 8-gauge white wire to the black Ground stud.
- Connect the 14-gauge orange wire to the Liftgate (+) stud.
- Connect the 16-gauge yellow wire to the Ignition stud.

Installation Complete.

# SELECT-25 INSTALLATION GUIDE

## PART LIST



PART# MOD00075  
SELECT CONTROLLER  
REPLACEMENT



PART# MOD00070  
CONTROL MODULE



PART# H-00286  
50 FT MAIN HARNESS



PART# NB00036  
DUAL/SINGLE POLE NOSEBOX



**PART# H-00288**  
**7-WAY AUX HARNESS**



**PART# BK-1049 (Revision B)**  
**TERMINAL BAG KIT**



**PART# BK-1054 (Revision B)**  
**HARDWARE BAG KIT**



# SELECT-25 INSTALLATION GUIDE



PART# SELECT-25  
SELECT WITH DUAL POLE  
COMBO AND AUX

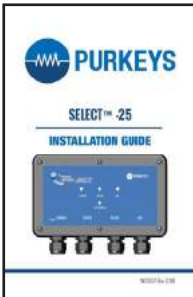

PART# INST037  
SELECT-25 INSTALLATION  
GUIDE



PART# INST028  
SELECT DIAGNOSTIC GUIDE

## LIMITED COMMERCIAL WARRANTY POLICY

Purkeys Fleet Electric, Inc. (hereafter “Purkeys”), warrants each product to be free of defects in material or workmanship under normal use and service. This warranty is for the benefit of Original Equipment Manufacturers, Dealers, Warehouse Distributors, Fleets, or other End Users (hereafter “Customers”) and covers products manufactured by Purkeys and sold new to Customers either directly by Purkeys or by its authorized dealers, distributors, or agents. The length of the Warranty Period is 36 months.

The warranty period commences on the in-service or install date and is not transferable. Failure to provide the in-service or install date on the warranty claim form will cause the warranty period to begin on the date the part was manufactured or date of sale recorded on the original sales invoice, whichever is earlier.

A completed warranty claim form should accompany all parts submitted to Purkeys for consideration for repair or replacement under warranty. The submitted claim form should contain all of the information required. Lack of a properly or fully completed claim form will result in delay or denial of warranty claim. Claims must be submitted no later than 30 days after part is removed.

This warranty does not apply if, in sole judgement of Purkeys, the product has been damaged or subjected to accident, faulty repair, improper adjustment, improper installation or wiring, neglect, misuse, or alteration or if the product failure is caused by defects in peripheral vehicle components or components attached to the Product or failure of a part not manufactured by Purkeys.

This warranty shall not apply if any Purkeys product is used for a purpose for which it is not designed or is in any way altered without the specific prior written consent of Purkeys. ANY Product alleged by a Customer to be defective must be inspected by Purkeys as a part of the warranty claims process in order to confirm that the part has failed as a result of a defect in material or workmanship.

Transportation for products and parts submitted to Purkeys for warranty consideration must be prepaid by Customer. Repaired or replaced products and or components will be returned to Customer pre-paid by Customer or “freight collect” to the address provided by Customer in the warranty claim form. No charge will be made for labor or material in effecting such repairs.

The Warranty provided by Purkeys hereunder is specifically limited to repair or replacement of the Product as Purkeys deems most appropriate in its sole discretion. Purkeys neither assumes nor authorizes any other person to assume on its behalf any other warranty or liabilities in connection with Purkeys products. The Warranty does not apply to fuses or other “consumable” or maintenance items which are or may be a part of any Purkeys product.

**THIS WARRANTY DOES NOT APPLY TO LOSS OF VEHICLE OR EQUIPMENT, LOSS OF TIME, INCONVENIENCE, OR OTHER INCIDENTAL OR CONSEQUENTIAL DAMAGES. PURKEYS SPECIFICALLY DISCLAIMS AND SHALL NOT BE LIABLE FOR INCIDENTAL OR CONSEQUENTIAL DAMAGES arising out of or from the use of Purkeys products by the Customer.**

**THIS LIMITED WARRANTY IS IN LIEU OF ALL OTHER WARRANTIES, INCLUDING COMMON LAW WARRANTIES OF FITNESS FOR A PARTICULAR PURPOSE, MERCHANTABILITY, AND ANY OTHER EXPRESS OR IMPLIED WARRANTIES. ALL OTHER SUCH WARRANTIES ARE SPECIFICALLY DISCLAIMED.**

This Limited Commercial Warranty supersedes all previous Warranty Policies issued by Purkeys and any of its suppliers.

# SELECT-25 INSTALLATION GUIDE



***WATT Keeps You Trucking***