

PURKEYS

SELECT™-22

INSTALLATION GUIDE



CONTENTS

General Information.....	2
Mounting the Select Controller.....	3
Dual/Single Pole Nosebox Installation	4
Reefer Harness Installation.....	4
Main Harness Installation.....	13
Part List	17
Limited Commercial Warranty Policy	20

GENERAL INFORMATION

The Purkeys Select™ system allows charging from multiple sources and improves the charging of liftgate batteries by utilizing a DC/DC converter to boost the voltage for optimal charging. The boost in voltage overcomes the normal voltage drop caused by the extended distance between the liftgate batteries and the vehicle charging system. Also, in cold temperatures batteries require increased charging voltages to maintain a high state of charge. The DC/DC converter in the Select system compensates for temperature by providing higher charging voltages in cold weather. The result is well-charged liftgate batteries that will last longer and have ample power for liftgate operation.

The Select system is automatic and has easy-to-interpret LED indicators to assure drivers and technicians of proper system function. The Select Controller increases the time that the DC/DC converter can charge the liftgate batteries by automatically choosing the best available source of power (tractor or reefer) and by monitoring the source power and “extending” the liftgate battery charge time to take full advantage of the available power, without compromising the source batteries’ ability to crank the engine.

The Select system provides opportunity charging for liftgate batteries that is essential in low mileage, high frequency liftgate operation applications. The LED indicators clearly show the status of the source as well as the status of the liftgate batteries. A quick glance at the Select Controller assures the driver that the liftgate batteries are ready to go, or alerts the driver that the batteries need maintenance.

SELECT-22 INSTALLATION GUIDE

MOUNTING THE SELECT CONTROLLER

Step 1: Using the supplied mounting screws, mount the Select Controller at the front of the trailer via the mounting holes on the plate.



NOTE: Do not block the LED status decal on the side of the Select when mounting the Select Controller.



Installation Complete.

DUAL/SINGLE POLE NOSEBOX INSTALLATION

Step 1: Mount the dual/single pole nosebox close to the Select Controller.

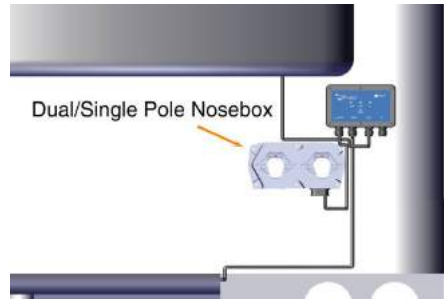

Installation Complete

REEFER HARNESS INSTALLATION

 Reefer harness installation will vary based on reefer manufacture and model. The reefer unit must be equipped with liftgate charging capability (i.e., it must have an accessory alternator or dedicated liftgate charger and charge cables that connect to liftgate batteries). Choose the correct application from the options below:

- Option 1: Thermoking Precedent Reefer with one internal charger and supplemental power package (accessory alternator). See page 5.
- Option 2: Carrier Vector 8600MT Reefer with two internal chargers and no alternator. See page 9.
- Option 3: Reefer with standard offering 65 amp alternator and no internal charger. See page 11.

Severe Service Kit (Not Included)

The Purkeys' Select system can be enhanced for Severe Service applications by being paired with a parallel circuit powered by a dual pole or reefer connection. The Purkeys' Severe Service Kits provide an added route for power to travel to the trailer liftgate batteries. This kit works in conjunction with our Select system.

SELECT-22 INSTALLATION GUIDE

The Select uses two-stage battery charging: bulk charging and topping off. When a trailer is equipped with a Severe Service Kit, the dual pole and/or reefer alternator helps during the early stages of bulk charging (when the battery is low or right after the liftgate is operated). As the battery state of charge increases, the Select takes over the charging until the batteries are fully charged. This occurs because the voltage level supplied by the dual pole alone is not as capable for topping off the charge of the liftgate batteries. The Select in parallel with the dual pole and/or reefer alternator assures that both the bulk charging and topping off of the liftgate batteries are optimized.

Option 1: Thermo King Precedent Reefer with One Internal Charger and Supplemental Power Package (Accessory Alternator)

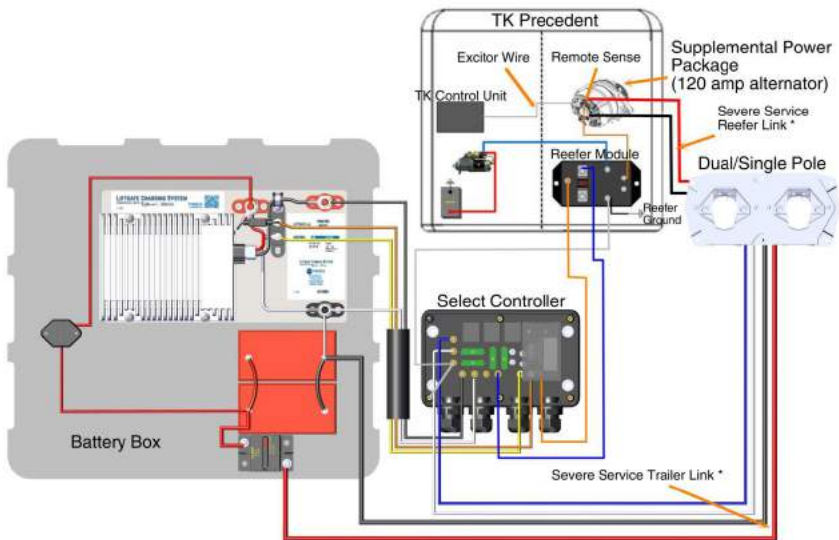

* For Severe Service applications, use the following kits:

- CA00136 (SEVERE SERVICE TRAILER LINK 53 FT)
- CA00137 (SEVERE SERVICE TRAILER LINK 48 FT)
- CA00138 (SEVERE SERVICE TRAILER LINK 23 FT)
- H-00495 (SEVERE SERVICE REEFER LINK)

Thermo King Precedent Models C-600, C-600M, S-600, S-700, S-600M, S-600DE, S-610M, and S-610DE that are equipped with a battery charger must have the supplemental power package installed prior to connecting any external loads, including the Purkeys Select System. Connecting external loads directly to the reefer battery or any part of the TRU system MAY VOID the Reefer Unit warranty.

Installers MUST follow the step-by step procedures outlined in the Trailer Installation Manual TK 55681-11-IM (Rev.6,04/17) Battery Charger Kits, and Supplemental Power Package Retrofit Kits.

It will be necessary to reconfigure the reefer unit to accept the supplemental power package (see image below).

Reconfiguring the SR4 Controller

Reconfiguring the SR4 Controller

The unit will need to be reconfigured after removing an alternator and installing a battery charger or when adding supplemental power package.

1. In HMI Guarded Access go to **Hardware Configuration**.
2. Select **Choices** (NONE, 30 Amp, 120 Amp)
 - Select NONE - If the unit is equipped with an alternator.
 - Select 30 Amp - If the unit is equipped with a 30 Amp battery charger.
 - Select 120 Amp - If the unit is equipped with a 120 Amp battery charger.

NOTE: If no choice is selected, the default is NONE.

3. If you installed the supplemental power 120A stand alone alternator you must go to the Aftermarket Alternator and turn it on.

Troubleshooting

1. Make battery
2. Rewire when
3. Make system
4. Check

Image from: Thermo King Trailer Installation Manual TK55681-11-IM, Battery Charger Kits and Supplemental Power Package Retrofit Kits.

SELECT-22 INSTALLATION GUIDE

Note: If the fuse is in Position 1, the module only senses if the reefer is charging the liftgate batteries. If the fuse is in Position 2 (see page 11, Step 1), the module pulls current from the reefer unit to charge the liftgate batteries through the Purkeys Select.



Note: If the 30 amp midi fuse is not positioned correctly, the reefer unit will not function properly as an input source for the Select Liftgate Charging System.

Step 2: Route the jacketed 2-conductor reefer module harness up toward the reefer compartment. Mount the module as close as possible to the starter positive and engine block ground post.

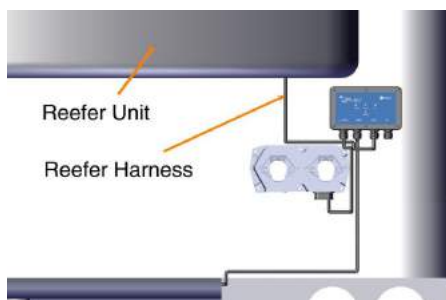

Caution: Avoid routing harness next to fuel lines.

Note: Place the cable clamps along the reefer harness every 6 inches to ensure proper support for the cable. Avoid sharp edges and possible chaffing points.

Step 3: Connect the reefer harness white ground wire to the reefer engine block ground and tighten.



Note: When adding a ground to the engine block, the terminals need to be mounted 30 degrees from each other, and the biggest terminal must be closest to the engine block to ensure a good ground terminal connection.

Step 4: Connect the reefer harness blue positive wire to the reefer starter positive post.



Note: Make sure no wire is left hanging and that all clamps and cable ties are no further than 6 inches away from each other.

Note: With the 2-pin harness (Sense, EXC) connected to the 120 Amp Accessory Alternator, connect the remote sense wire to the remote sense wire from the reefer harness module. (This harness is not included in this kit and must be previously installed. It is offered in our Severe Service Reefer Link.)

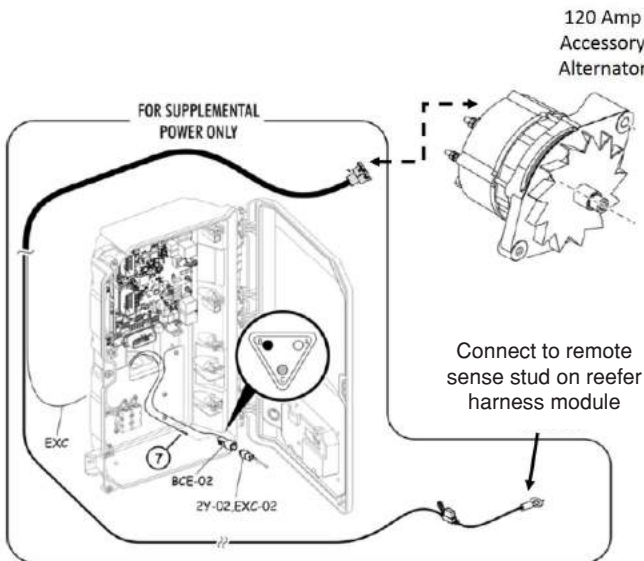

Image from: Thermo King Trailer Installation Manual TK55681-11-IM, Battery Charger Kits and Supplemental Power Package Retrofit Kits.

Note: The remote sense wire is combined with the alternator excite wire that connects to the Thermoking control unit.

Installation Complete.

SELECT-22 INSTALLATION GUIDE

Option 2: Carrier Vector 8600MT Reefer with Two Internal Chargers and No Alternator

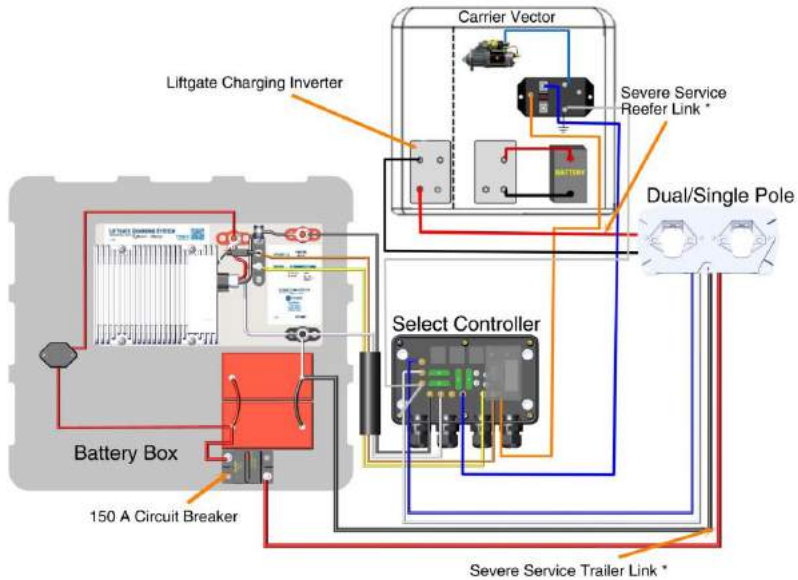

* For Severe Service applications, use the following kits:

- CA00136 (SEVERE SERVICE TRAILER LINK 53 FT)
- CA00137 (SEVERE SERVICE TRAILER LINK 48 FT)
- CA00138 (SEVERE SERVICE TRAILER LINK 23 FT)
- H-00495 (SEVERE SERVICE REEFER LINK)

Note: Position 1 is only sensing if the reefer is charging liftgate batteries and position 2 (see page 11, Step 1) will be pulling current from the Reefer unit to charge liftgate batteries through the Purkeys Select.



Note: If the 30 amp midi fuse is not positioned correctly, the reefer unit will not function properly as an input source for the Select Liftgate Charging System.

Step 1: Route the jacketed 2-conductor reefer module harness up toward the reefer compartment. Mount the module as close as possible to the starter positive and engine block ground post.

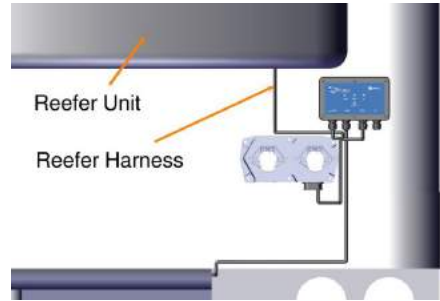

Note: Place the cable clamps along the reefer harness every 6 inches to ensure proper support for the cable. Avoid sharp edges and possible chaffing points.

Step 2: Connect the reefer harness white ground wire to the reefer engine block ground and tighten.



Caution: Avoid routing harness next to fuel lines.

Note: When adding a ground to the engine block, the terminals need to be mounted 30 degrees from each other, and the biggest terminal must be closest to the engine block to ensure a good ground terminal connection.

Step 3: Connect the reefer harness blue positive wire to the reefer starter positive post.



Note: Make sure no wire is left hanging and that all clamps and cable ties are no further than 6 inches away from each other.

Installation Complete.

SELECT-22 INSTALLATION GUIDE

Option 3: Reefer with Standard Offering 65 Amp Alternator and No Internal Charger

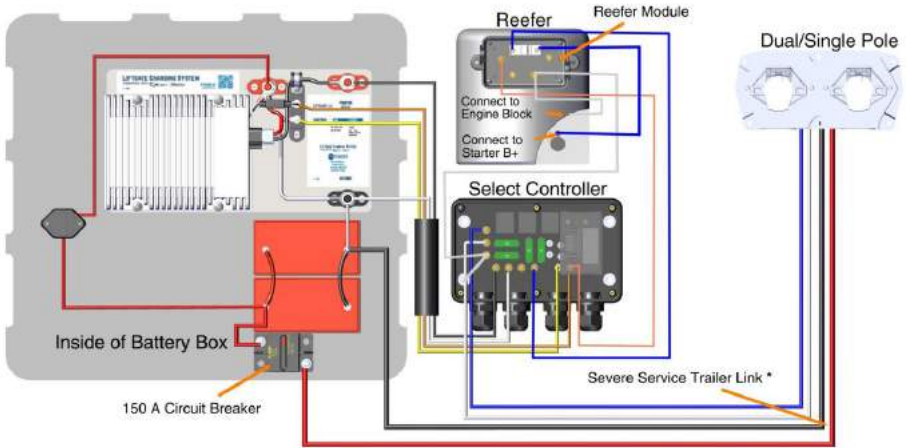

* For Severe Service applications, use the following kits:

- CA00136 (SEVERE SERVICE TRAILER LINK 53 FT)
- CA00137 (SEVERE SERVICE TRAILER LINK 48 FT)
- CA00138 (SEVERE SERVICE TRAILER LINK 23 FT)

Step 1: Before reefer harness installation, remove the lid from the reefer harness module. Position the 30 amp midi fuse in Position 2 as shown to ensure proper function of this module.



Note: If the 30 amp midi fuse is not positioned correctly, the reefer unit will not function properly as an input source for the Select Liftgate Charging System.

Step 2: Route the jacketed 2-conductor reefer module harness up toward the reefer compartment. Mount the module as close as possible to the starter positive and engine block ground post.

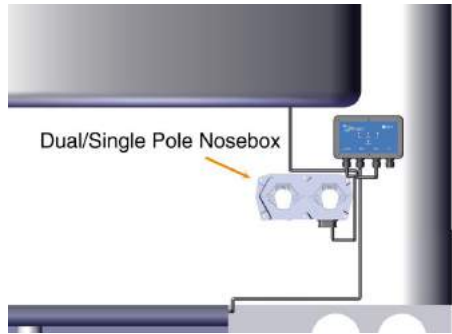

Note: Place the cable clamps along the reefer harness every 6 inches to ensure proper support for the cable. Avoid sharp edges and possible chaffing points.

Step 3: Connect the reefer harness white ground wire to the reefer engine block ground and tighten.



Caution: Avoid routing harness next to fuel lines.

Note: When adding a ground to the engine block, the terminals need to be mounted 30 degrees from each other, and the biggest terminal must be closest to the engine block to ensure a good ground terminal connection.

Step 4: Connect the reefer harness blue positive wire to the reefer starter positive post.



Note: Make sure no wire is left hanging and that all clamps and cable ties are no more than 6 inches away from each other.

Installation Complete.

SELECT-22 INSTALLATION GUIDE

MAIN HARNESS INSTALLATION

Step 1: Route the Select 4-conductor jacketed DC/DC converter main harness behind the front plate, then behind the header plate through the air/electrical tube to the center channel.

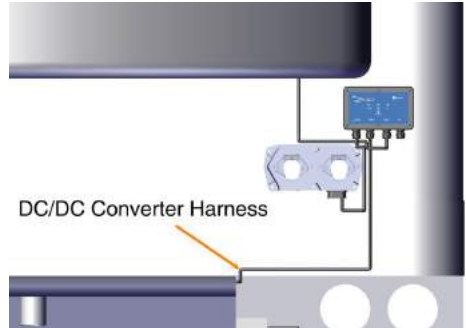

Step 2: Route the Select jacketed 4-conductor main harness in the center channel toward the back of the trailer. Secure with wire ties or cable clamps as you go.



Place the cable clamps along the 4-conductor jacketed wire every 6 inches to ensure proper support for the cable. Avoid sharp edges and possible chaffing points.

Step 3: Once you are near the liftgate battery box, begin routing the Select 4-conductor main harness into the liftgate battery box through a dome nut or rubber grommet.



Note: Ensure that the 4-conductor jacketed wire enters the liftgate battery box through a dome nut or rubber grommet to prevent chaffing the wire, which could result in possible electrical short in the system.

Step 4: Position the Select 4-conductor main harness so it will reach the 6-stud strip and all the slack has been taken up. Mark the wire so it can be taken back out of the battery box to be terminated.

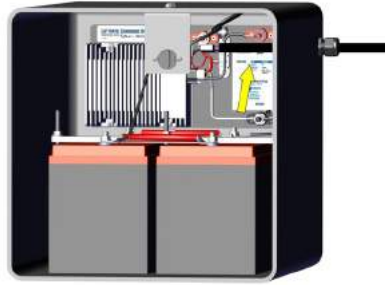

Note: If your battery box includes a slide-out tray, include enough slack to allow the tray to fully extend without tugging the wire connections.

Step 5: Pull the conductor out of the box (easier to work on), and cut off the excess at the mark.



Step 6: Cut about 8 inches off the jacketed portion off the conductor.

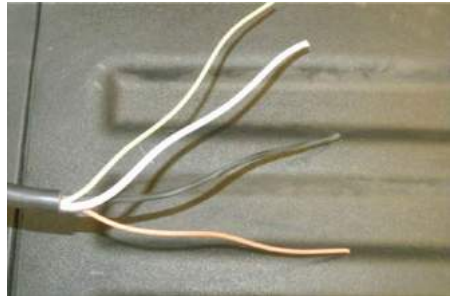

Step 7: Apply the supplied inch black heat shrink where the jacket was stripped off.

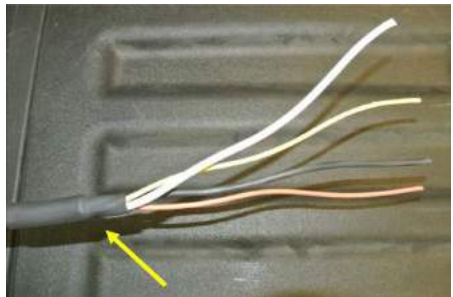

SELECT-22 INSTALLATION GUIDE

Step 8: Strip 3/8 inch of insulation off all 4 wires.

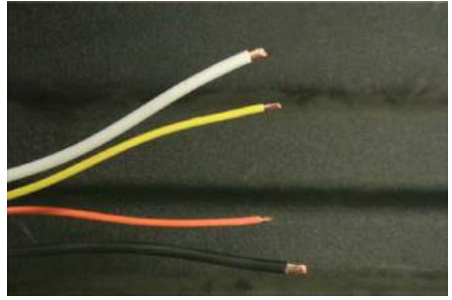

Step 9: Slide the supplied red 1/2 inch heat shrink over the orange, yellow, and black wires. Slide the supplied black 1/2 inch heat shrink over the white wire.

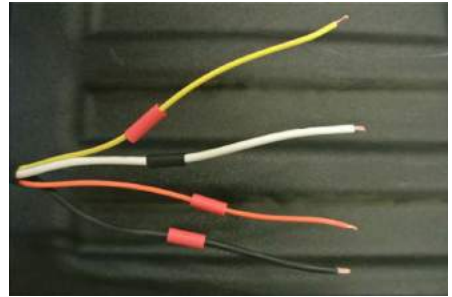

Step 10: Crimp terminals onto the 4 wires. The white and black 8-gauge wires use the 3/8 ring terminals, and the 14-gauge orange and 16-gauge yellow wires use the #10 ring terminals.

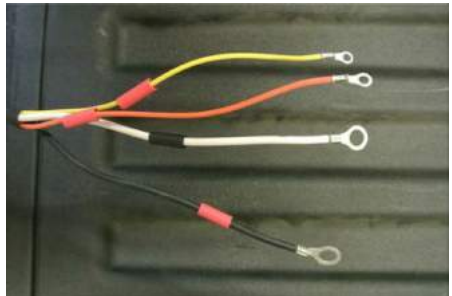

Step 11: Position the heat shrink over the crimps and apply heat to the 4 terminals.

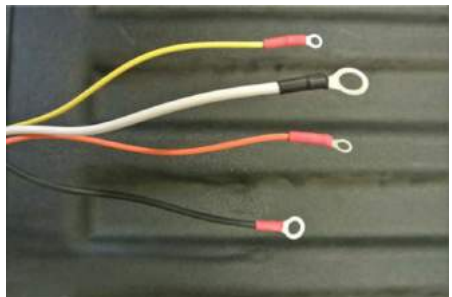

Step 12: Re-route the jacketed wire back into the battery box.

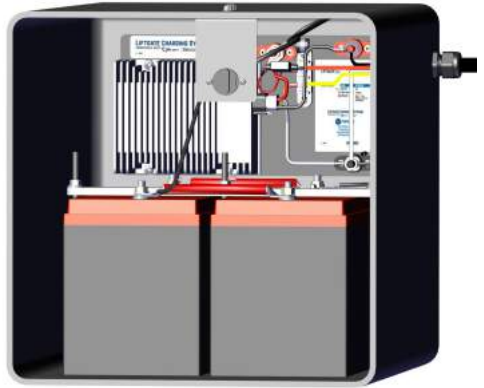

- Connect the 8-gauge black wire to the red positive Input Stud.
- Connect the 8-gauge white wire to the black ground stud.
- Connect the 14-gauge orange wire to the Liftgate (+) stud.
- Connect the 16-gauge yellow wire to the Ignition stud.

Installation Complete

SELECT-22 INSTALLATION GUIDE

PART LIST



PART# MOD00075
SELECT CONTROLLER
REPLACEMENT



PART# MOD00070
CONTROL MODULE



PART# H-00286
50 FT MAIN HARNESS



PART# H-00494
HARNESS, REEFER TO
SELECT INCLUDING
MODULE



PART# NB00036
DUAL/SINGLE POLE NOSEBOX



PART# BK-1049 (Revision B)
TERMINAL BAG KIT



PART# BK-1054 (Revision B)
HARDWARE BAG KIT



PART# F00062
30 AMP MIDI FUSE

SELECT-22 INSTALLATION GUIDE



PART# SELECT-22
SELECT W/REEFER AND DUAL
COMBO



PART# INST034
SELECT-22 INSTALLATION
GUIDE



PART# INST028
SELECT DIAGNOSTIC GUIDE

LIMITED COMMERCIAL WARRANTY POLICY

Purkeys Fleet Electric, Inc. (hereafter "Purkeys"), warrants each product to be free of defects in material or workmanship under normal use and service. This warranty is for the benefit of Original Equipment Manufacturers, Dealers, Warehouse Distributors, Fleets, or other End Users (hereafter "Customers") and covers products manufactured by Purkeys and sold new to Customers either directly by Purkeys or by its authorized dealers, distributors, or agents. The length of the Warranty Period is 36 months.

The warranty period commences on the in-service or install date and is not transferable. Failure to provide the in-service or install date on the warranty claim form will cause the warranty period to begin on the date the part was manufactured or date of sale recorded on the original sales invoice, whichever is earlier.

A completed warranty claim form should accompany all parts submitted to Purkeys for consideration for repair or replacement under warranty. The submitted claim form should contain all of the information required. Lack of a properly or fully completed claim form will result in delay or denial of warranty claim. Claims must be submitted no later than 30 days after part is removed.

This warranty does not apply if, in sole judgement of Purkeys, the product has been damaged or subjected to accident, faulty repair, improper adjustment, improper installation or wiring, neglect, misuse, or alteration or if the product failure is caused by defects in peripheral vehicle components or components attached to the Product or failure of a part not manufactured by Purkeys.

This warranty shall not apply if any Purkeys product is used for a purpose for which it is not designed or is in any way altered without the specific prior written consent of Purkeys. ANY Product alleged by a Customer to be defective must be inspected by Purkeys as a part of the warranty claims process in order to confirm that the part has failed as a result of a defect in material or workmanship.

Transportation for products and parts submitted to Purkeys for warranty consideration must be prepaid by Customer. Repaired or replaced products and or components will be returned to Customer pre-paid by Customer or "freight collect" to the address provided by Customer in the warranty claim form. No charge will be made for labor or material in effecting such repairs.

The Warranty provided by Purkeys hereunder is specifically limited to repair or replacement of the Product as Purkeys deems most appropriate in its sole discretion. Purkeys neither assumes nor authorizes any other person to assume on its behalf any other warranty or liabilities in connection with Purkeys products. The Warranty does not apply to fuses or other "consumable" or maintenance items which are or may be a part of any Purkeys product.

THIS WARRANTY DOES NOT APPLY TO LOSS OF VEHICLE OR EQUIPMENT, LOSS OF TIME, INCONVENIENCE, OR OTHER INCIDENTAL OR CONSEQUENTIAL DAMAGES. PURKEYS SPECIFICALLY DISCLAIMS AND SHALL NOT BE LIABLE FOR INCIDENTAL OR CONSEQUENTIAL DAMAGES arising out of or from the use of Purkeys products by the Customer.

THIS LIMITED WARRANTY IS IN LIEU OF ALL OTHER WARRANTIES, INCLUDING COMMON LAW WARRANTIES OF FITNESS FOR A PARTICULAR PURPOSE, MERCHANTABILITY, AND ANY OTHER EXPRESS OR IMPLIED WARRANTIES. ALL OTHER SUCH WARRANTIES ARE SPECIFICALLY DISCLAIMED.

This Limited Commercial Warranty supersedes all previous Warranty Policies issued by Purkeys and any of its suppliers.

SELECT-22 INSTALLATION GUIDE



WATT Keeps You Trucking